

# BOSS®

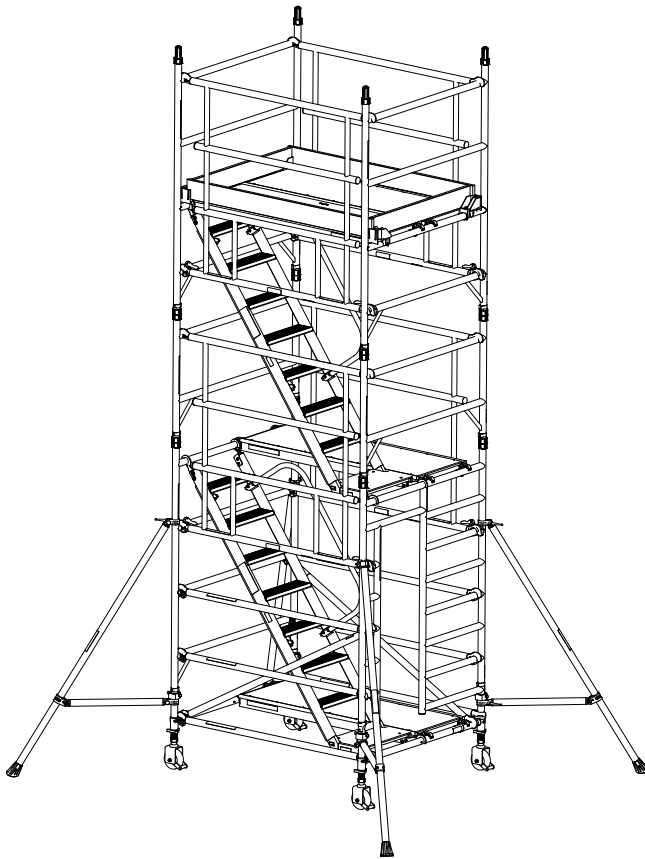

## Staircase

with Multi-Guard  
Mobile Aluminium Tower  
AGR - Advance Guardrail Method

Instruction Manual



# Contents

## 1 Safety First

---

1.1	Introduction	2
1.2	Tower Designation	3
1.3	Maintenance - storage - transport	3

## 2 Building the Tower

---

2.1	Pre-Assembly Checks	4
2.2	Component Diagram	5
2.3	Quantity Schedule	6
2.4	Stabilisers	7
2.5	Assembly	8
2.6	Dismantling	17

## 3 Using the Tower

---

3.1	Safety Checklist	18
3.2	Pre-Use Checklist	18
3.3	Use	19
3.4	Movement of the assembled prefabricated tower scaffold	20

# 1 Safety First

## 1.1 Introduction

---

Please read this instruction manual carefully.

THIS INSTRUCTION MANUAL SHALL BE AVAILABLE AT THE LOCATION OF USE OF THIS MOBILE ACCESS TOWER.

THIS PRODUCT SHALL ONLY BE USED IN ACCORDANCE WITH THIS MANUAL.



**FAILURE TO FOLLOW THESE INSTRUCTIONS MAY LEAD TO DEATH OR SERIOUS INJURY.**

IF ANY ASPECT OF THESE INSTRUCTIONS CONFLICTS WITH LOCAL REGULATIONS PLEASE CONTACT WERNER UK SALES & DISTRIBUTION LTD. FOR ADVICE.

Please note that diagrams are for illustrative purposes only.

Instruction manuals are also available to download at [www.bossacesstowers.com](http://www.bossacesstowers.com).

BoSS mobile aluminium towers are light-weight scaffold towers used throughout the building and construction industry for both indoor and outdoor access solutions where a stable and secure platform is required. Ideal for maintenance and installation work or short-term access, the highly versatile towers provide a strong working platform for a variety of heights.

Verification and assessment documentation is held by Werner UK Sales & Distribution Ltd.

If you need further information, design advice, additional instruction manuals or any other help with this product, please contact Werner UK Sales & Distribution Ltd. on +44 (0)1621 745900 or email [uk.customercare@wernerco.com](mailto:uk.customercare@wernerco.com).

### Compliances



The BoSS Staircase mobile tower system with Multi-Guard has been designed, tested, approved and certified to EN 1004-1:2020.

This instruction manual is in compliance with EN1298-IM-en.

# 1 Safety First

## 1.2 Tower Designation

### EN 1004 3 8/12 AXXX H2

Design Code

Load Class (2 = 153kg/m<sup>2</sup> UDL, 3 = 204kg/m<sup>2</sup> UDL)

Max. Platform Height Outdoors (m)

Max. Platform Height Indoors (m)

Access Method

A = Stairway, B = Stair ladder, C = Inclined Ladder, D = Vertical Ladder

Clear Height Class (H1 = 1.85m, H2 = 1.90m)

## 1.3 Maintenance - storage - transport

- The BoSS mobile tower system is robust and requires little maintenance.
- All components and their parts should be regularly inspected to identify damage, particularly to joints.
- Refer to the BoSS Inspection Guidance for detailed inspection and maintenance advice, the guidance is available to download at: [www.bossacesstowers.com](http://www.bossacesstowers.com).
- Threads, hinges, and brace latches may be lubricated with light oil. Ensure oil does not contaminate climbing or walking surfaces.
- Safety labels should be kept legible. Replacement labels are available from Werner UK Sales & Distribution Ltd.
- Surfaces should be kept reasonably free of dried paint, plaster etc.
- Use of solvents on wooden platform surfaces and plastic components should be avoided.
- Components should be stored in clean, dry conditions with due care to prevent damage.
- During transportation ensure components are not damaged by excessive strapping forces.

## 2 Building the Tower

### 2.1 Pre-Assembly Checks

---

- Check overhead that the area into which the structure is to be erected contains no obstructions, particularly electrical or radio radiation hazards. The structure is conductive.
- Ensure the ground on which the mobile access tower is to be erected is capable of supporting the tower in use.
- Check the surface is level within the 210mm range of the adjustable legs.
- Adjustable legs should only be used for levelling purposes and never to gain extra height.
- Only climb the tower from the inside using the access method provided.
- Tower scaffolds are not designed to be lifted or suspended.
- This tower provides a work platform. It must not be used to access other structures.
- Ensure the safe working load on the structure is not exceeded.
- Tools and materials should be lifted using a reliable lifting material (e.g. a strong rope) employing a reliable knot (e.g. clove hitch) to ensure safe fastening and always lift within the footprint of the prefabricated tower scaffold (i.e. within the area bounded by the stabilisers).
- Check this manual is available and its contents familiar to all those involved.
- If assembling outdoors; check the forecast windspeed. The assembled tower is certified to wind forces equating to 27mph, but handling components under those conditions would be hazardous. Also consider the wind funnelling effect of nearby buildings.
- Towers greater than 8.2m platform height are for indoor use only.
- This structure is designed to be self-supporting under the loading condition requirements of EN 1004-1:2020 and does not require tying in. Consideration should be given to potential wind conditions if the tower is left unattended.

## 2 Building the Tower

### 2.2 Component Diagram

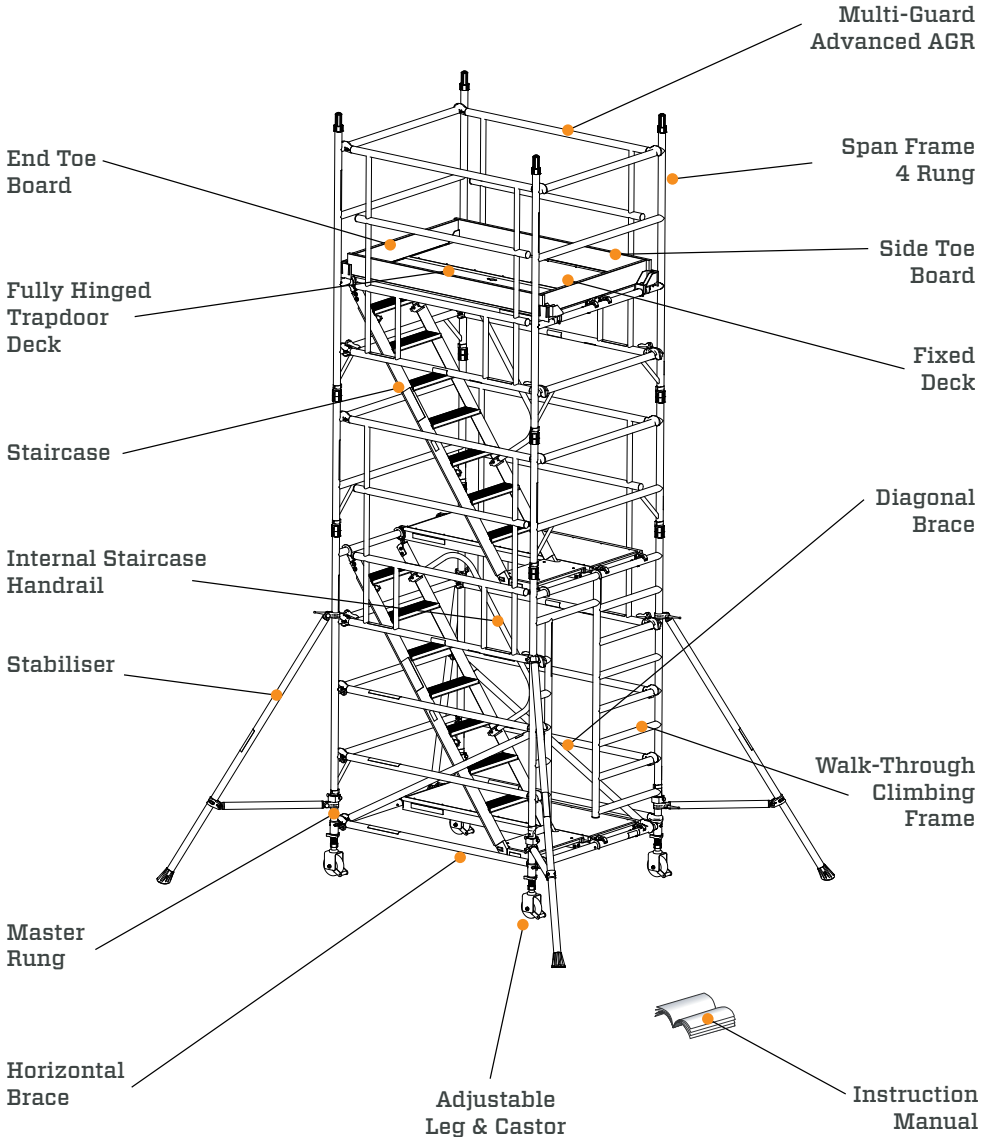

## 2.3 Quantity Schedule

**BoSS 1450 Staircase to EN 1004: Available in 2 lengths - 1.8m and 2.5m**

Component code	Component	Working Height (m)		Internal or External Use				Internal Use Only	
		Platform Height (m)		4.4	6.4	8.4	10.4	12.4	14.4
32842300	Castor 150mm			4	4	4	4	4	4
33551300	Adjustable Leg			4	4	4	4	4	4
33451300	Master Rung 1450			2	2	2	2	2	2
60551300	Span Frame 1450 2 Rung			2	2	2	2	2	2
60351300	Span Frame 1450 4 Rung			1	3	5	7	9	11
33151700	Walk-Through Climbing Frame 1450			1	1	1	1	1	1
30751100 / 30851100	Fully Hinged Trapdoor Deck 1.8m and 2.5m			1	1	1	1	1	1
30151100 / 30251100	Fixed Deck 1.8m and 2.5m			2	3	4	5	6	7
31251300 / 34851300	Horizontal Brace 1.8m and 2.5m (Red)			6	6	6	6	6	6
31351300 / 31451300	Diagonal Brace 2.1m and 2.7m (Blue)			2	2	2	2	2	2
33651300 / 33951300	Staircase 1.8m and 2.5m			1	2	3	4	5	6
33751300	Internal Staircase Handrail			1	2	3	4	5	6
34940700 / 34940800	Multi-Guard Advanced AGR 1.8m and 2.5m			2	4	6	8	10	12
30450900 / 30550900	Side Toe Board 1.8m and 2.5m			2	2	2	2	2	2
30350900	End Toe Board 1.45m			2	2	2	2	2	2
30150900	Toe Board Holder			4	4	4	4	4	4
31751300	SP7 Fixed Stabiliser			4	4	-	-	-	-
31851300	SP10 Telescopic Stabiliser			-	-	4	-	4	4
31951300	SP15 Telescopic Stabiliser			-	-	-	4	-	-
Tower Total Self-weight 1.8m (kgs)				175	240	317	382	446	511
Tower Total Self-weight 2.5m (kgs)				201	274	360	433	507	580
Max. Exerted Leg Load 1.8m (kgs)				130	135	180	190	310	325
Max. Exerted Leg Load 2.5m (kgs)				205	210	215	215	360	400



## 2 Building the Tower

### Assembly Variations

This section lists the permitted component variation from the Quantity Schedule.

Note: These substitutions must be made before assembly.

Stabilisers with Universal Clamps may be substituted:

Component Code	Description	Weight (kg)
31751400	SP7	4.0
31851400	SP10	9.0
31951400	SP15	13.1

Other Castor sizes and types may be substituted:

Component Code	Description	Weight (kg)
31842300	Diameter 150mm (Tyred)	3.2
32942300	Diameter 200mm	3.9
31942300	Diameter 200mm (Tyred)	3.9

### 2.4 Stabilisers

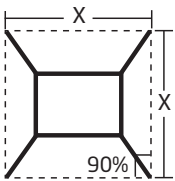

Double width 1450 tower		
Platform Length		
	1.8m	2.5m
SP7	3351	3629
SP10	4789	5100
SP15	5520	5838

SP10 and SP15 stabilisers must always be fully extended.

Position the lower clamp so that the arm is as close to horizontal as possible. Adjust the position of the top clamp to ensure the stabiliser foot is in firm contact with the ground. Ensure the clamps are secure.

## 2 Building the Tower

### 2.5 Assembly

This tower structure must be assembled, and components oriented, in accordance with this instruction manual. Deviation from this instruction manual is not permitted.



**THIS TOWER MUST NOT BE USED AS AN ANCHOR POINT FOR PERSONAL FALL PROTECTION EQUIPMENT.**

- No tools are required for assembly.
- The assembly uses the Advanced Guardrail method that provides collective fall protection.
  - Fit Multi-Guard frames in the locations described and ensure the claws are locked before standing on the platform.

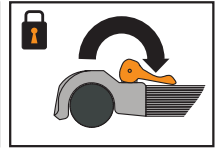
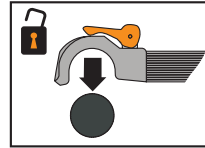

- The tower may be assembled by a single person, but it is recommended that two or more are used to pass up components on the taller assemblies.
- Components must be lifted within the footprint of the tower using a reliable method such as a strong rope with a clove hitch knot.
- Castor brakes should be locked as soon as the tower base is in position.
- The tower base should be levelled to within  $0.6^\circ$  before continuing the assembly.
- The adjustable legs are for levelling the tower only and not to be used to gain extra height.
- Ensure when the base is levelled the distance from the ground to the first climbing rung is less than 400mm.
- Stabilisers of the size specified in the quantity schedule should be fitted at the earliest opportunity.

## 2 Building the Tower

- 1 Fit a master rung to a 4 rung span frame but do not tighten the thumb screws at this stage.

Push castor and adjustable leg together and insert into frame. Now tighten the thumb screws.

Repeat with walk-through frame but ensure that the datum rivets on master rung are below the walk-through part of the frame.

Ensure all castors are locked.

NOTE: Adjustable legs are for levelling only. They are not to be used to gain extra height at the working level.

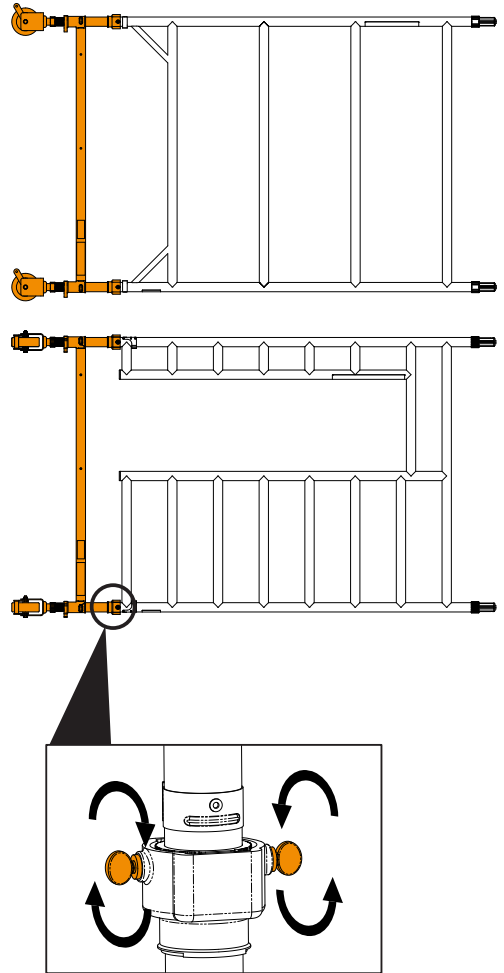

## 2 Building the Tower

- 2** Fit one 2 rung span frame to the top of the walk-through assembly. Ensure interlock clips are connecting the frames together.

Repeat with the span frame assembly.

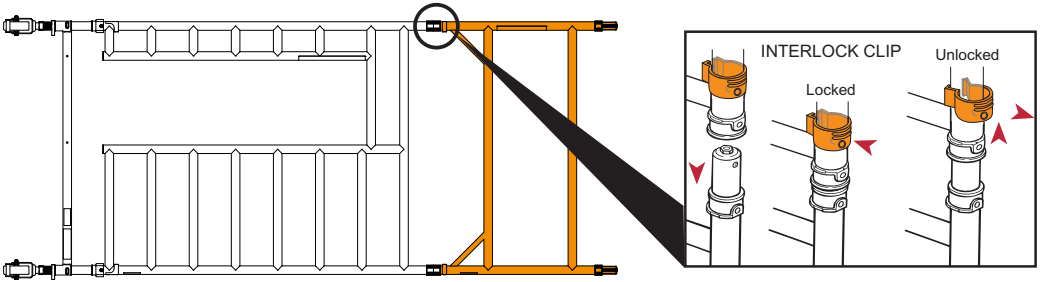

- 3** Fit one horizontal brace (red) onto the vertical of the span frame assembly, just above the bottom rung of the master rung, with the claw facing outwards. The frame will now be self-supporting.

Note: All locking claws must be opened before fitting and positively locked into position.

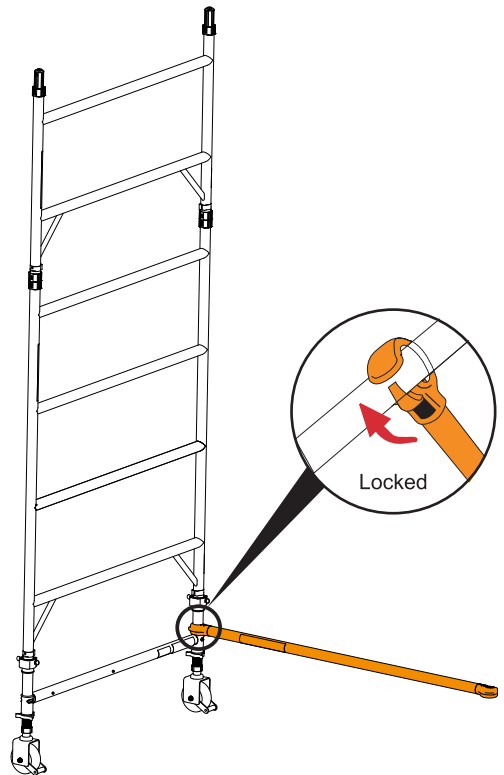

## 2 Building the Tower

**4** Position walk-through frame assembly as shown and fit the other end of the horizontal brace onto the vertical, just above the bottom rung.

Fit a second horizontal brace between the bottom rungs on the other side of the frames to square the tower.

Fit two diagonal braces (blue) in positions shown.

The structure must be vertical to within 1cm per metre. Ensure the frames are vertical and level by checking with a spirit level and setting the adjustable legs as required.

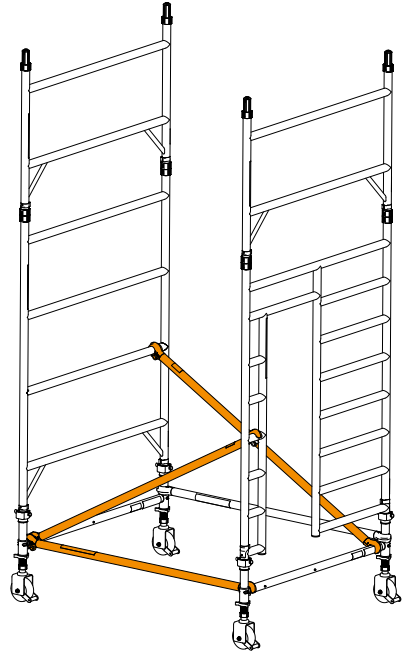

**5** Fit two horizontal braces to the rungs of the tower as shown.

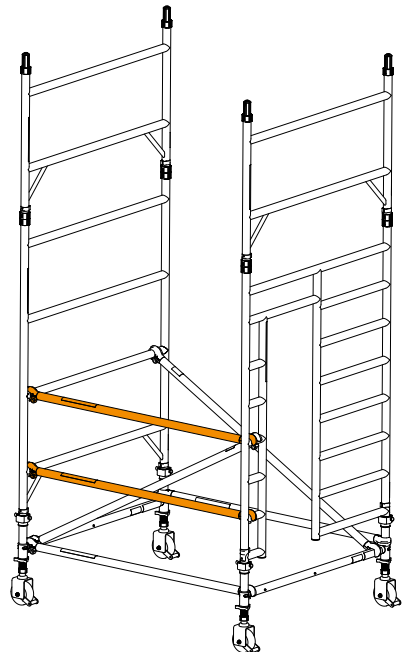

## 2 Building the Tower

**6** Fit an AGR on both sides of the tower. The top hooks of the AGR must be fitted to the top rungs of the 2 rung frame as shown.

The AGR should be placed up against the end frame verticals.

Ensure camlocks are engaged.

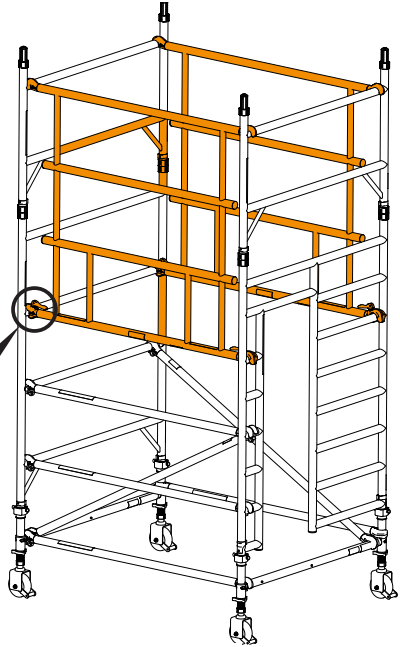
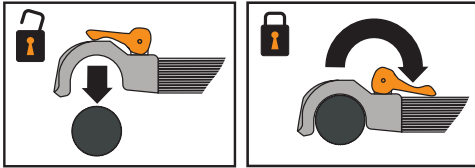

**7** Position a fixed deck next to the diagonal brace as shown. Fit the staircase unit between the master rung and the top cross member of the 4 rung span frame. Ensure that the staircase claws are positioned outside of the datum rivets on the master rung as shown and the staircase is aligned with the opening in the frame.

Ensure the staircase and deck wind latches are engaged.

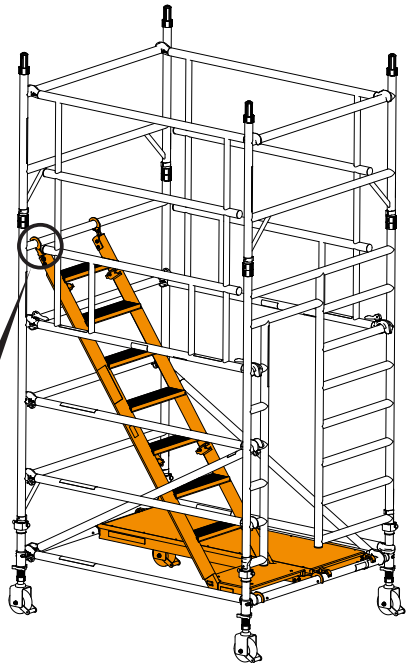
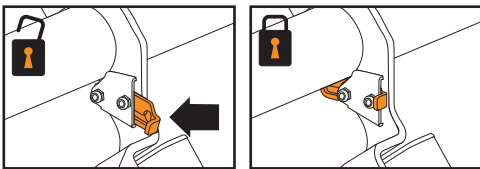

## 2 Building the Tower

**8** Fit a fixed deck to the top rung of the walk-through frame, directly above the lower fixed deck. Ensure the deck wind latches are engaged.

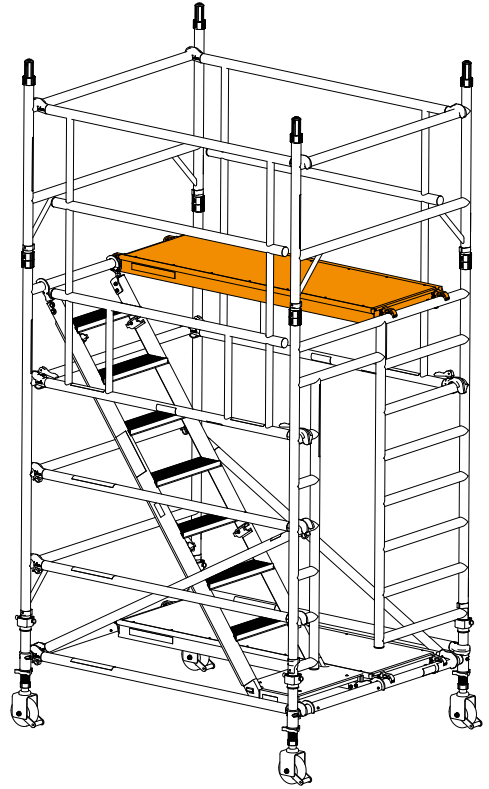

## 2 Building the Tower

- 9** Fit stabilisers (see notes on **page 7**).  
Telescopic stabilisers must always be fully extended.

Position lower clamps so that the lower arm is as close to horizontal as possible. Adjust the position of the top clamp to ensure the stabiliser foot is in firm contact with the ground. Ensure clamps are fully tightened.

Fit the internal staircase handrail to the inside face of the staircase as shown.

Climb the staircase, sit on the platform and fit a pair of temporary horizontal guardrails to the centre of the two top crossbars as shown.

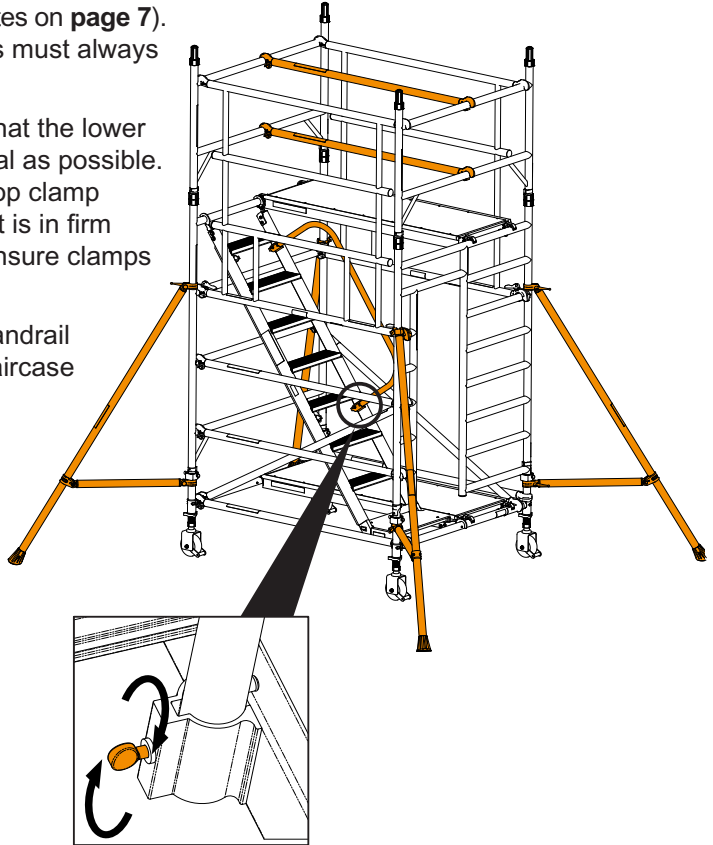



## 2 Building the Tower

**10** Standing on the fully guard-railed platform, fit two 4 rung span frames in positions shown.

Ensure interlock clips on frame members are in the 'locked' position.

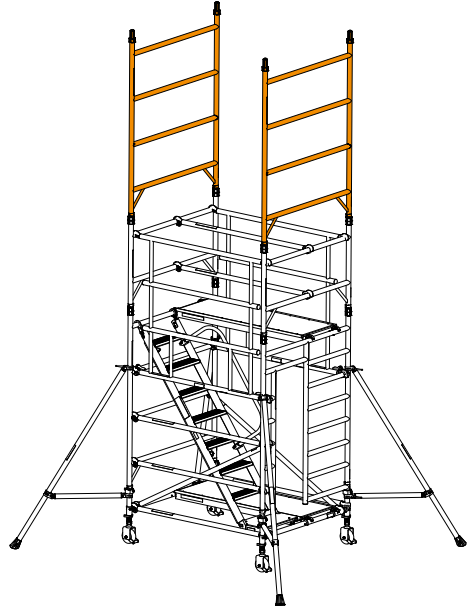

**11** Fit an AGR on both sides of the tower. The top hooks of the AGR must be fitted to the top rungs of the 4 rung frame as shown.

The AGR should be placed up against the end frame verticals.

Ensure camlocks are engaged.

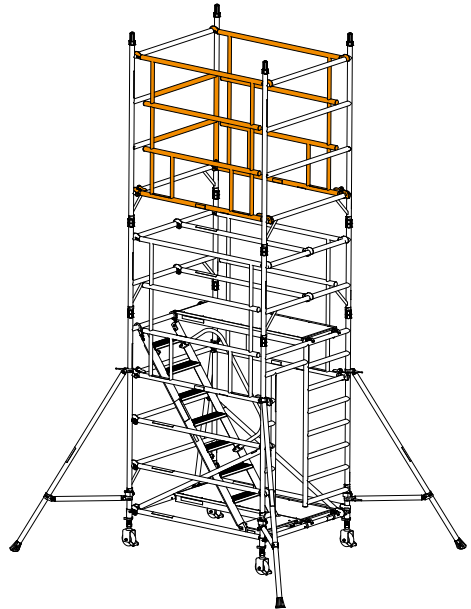

## 2 Building the Tower

**12** Standing on the fully guard-railed platform, fit the next staircase above and aligned with the first staircase with the landing claws fitted to the top cross member of the walk-through frame as shown.

Ensure staircase wind latches are engaged.

Remove the temporary inner horizontal braces and fit the internal staircase handrail to the inside face of the staircase as shown.

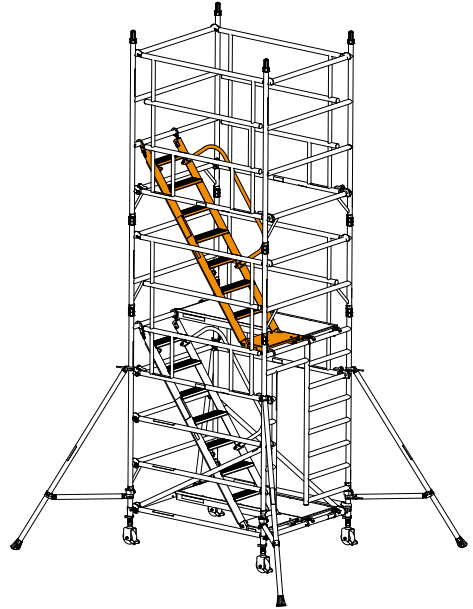

**13** Standing on the fully guard-railed platform, fit a trapdoor deck above the staircase ensuring the trapdoor opens towards the outside of the tower. Place a fixed deck next to the trapdoor deck.

Ensure all deck with latches are engaged.

The two temporary inner horizontal braces used during the assembly process, can now be fixed to the base of the tower on the far side as shown.

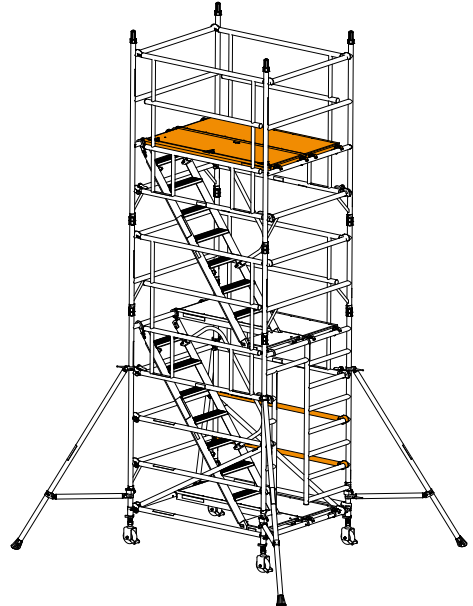

## 2 Building the Tower

**14** Continue the procedure until the required working height is reached, adding additional end frames, AGRs and staircases as shown on previous steps.

Fit toe board holders and toe boards around the edges of the top decks as shown.

**The tower is now complete.**

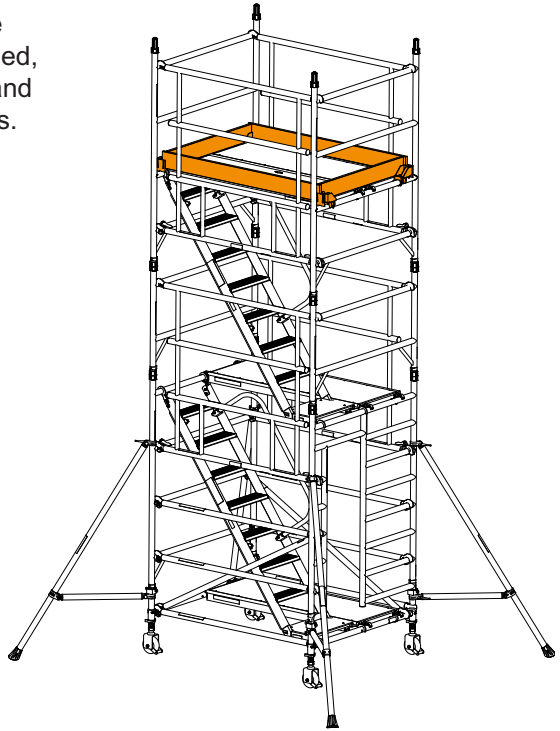

### 2.6 Dismantling

To dismantle the tower, reverse the assembly procedure.

## 3 Using the Tower

### 3.1 Safety Checklist

---

This inspection must be carried out before initial use, after moving the tower, if any environmental condition change that may affect the tower and at regular intervals determined by local regulations.

Local regulations may also specify other information to be supplied to the user. These regulations must be followed.

### 3.2 Pre-Use Checklist

---

Tower upright and level to within 0.6°	
Castor brakes locked	
All interlock clips engaged	
Braces/Guardrails correctly positioned	
All claws latched	
All platform wind latches engaged	
Correct stabiliser size fitted and positioned	
Toe boards fitted to working platform	
Instruction manual available to user	

---

## 3 Using the Tower

### 3.3 Use

---

- This tower must not be used as an anchor point for personal fall arrest equipment.
- The tower must only be climbed on the inside, using the access method specified.
- This tower provides a work platform. It must not be used to access other structures.
- Raising and lowering tools and materials must only be conducted within the tower footprint.
- Ensure the safe working load on the structure is not exceeded. See tower designation.
- Do not use boxes, stepladders or other objects to gain extra height.
- The adjustable legs are for levelling the tower only. They must not be used to gain extra height.
- Beware of horizontal forces that might cause instability. Maximum horizontal force = 30kg.
- Beware of high winds. This tower has been assessed as a freestanding structure for wind loads equating to 27mph (43kph, 12m/s). If greater windspeeds are forecast the tower must be moved to a sheltered location or dismantled while it is still safe to do so.
- Sheets, tarpaulins, or signage must not be attached to this tower outdoors.
- Towers above 8.2m platform height are for indoor use only.

## 3 Using the Tower

### 3.4 Movement of the assembled prefabricated tower scaffold

---

Ensure gloves or other suitable hand protection is worn.

#### Before

- Survey the route to be taken. Assess the ground condition/slope and any overhead obstructions or hazards.
- Tower stability will be improved by reducing the height before movement.
- If there is any doubt about the safety of the move the tower must be dismantled and reassembled in the new location.
- This tower is not designed to be lifted or suspended.
- Ensure there are no persons, tools, or materials on the tower.
- Release the castor brakes.
- Release the stabiliser top clamp to allow the feet to be raised a maximum of 25mm. Re-tighten the clamps.

#### During

- The tower must be moved only by manual effort, pushing at the base of the tower.
- Constant attention must be given to the position of the castors, stabiliser feet and the top of the tower.
- If there is any resistance to movement, stop and investigate the reason before continuing.

#### After

- As soon as the move is complete; lock the castor brakes, lower the stabiliser feet, and perform the pre-use inspection.





For further information and support for the Staircase or any other products and services, please contact:

Werner UK Sales & Distribution Ltd.  
Blackwater Trading Estate,  
The Causeway, Maldon,  
Essex, CM9 4LJ,  
United Kingdom

Werner Co Hungary Kft.  
6000 Kecskemét,  
Szt. Istvan Krt. 19.

☎ +44 (0)1621 745900

✉ [uk.customer@wernerco.com](mailto:uk.customer@wernerco.com)

🌐 [bossacesstowers.com](http://bossacesstowers.com)

Werner UK Sales & Distribution Ltd.  
is a manufacturer member of:

